

EKS - Rekkverk

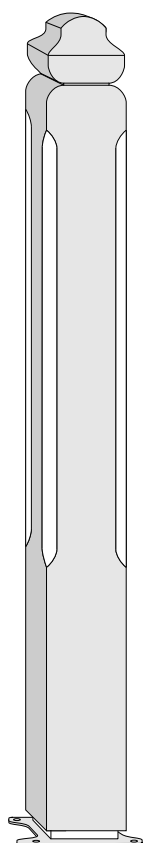

EKS-Søylefot-beslag

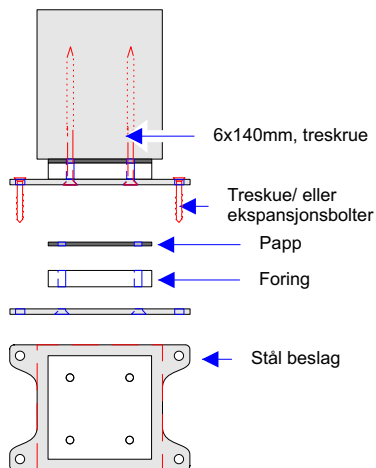

Sveitser 1

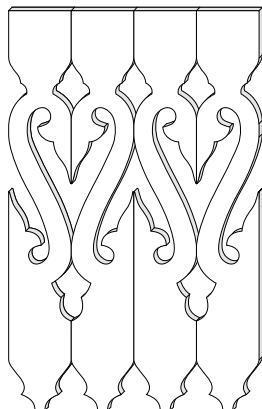

Dråpe

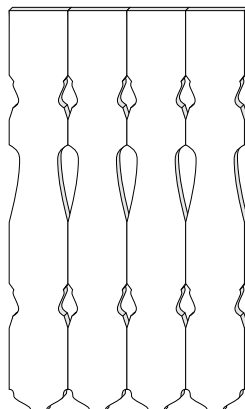

Gammel Askim

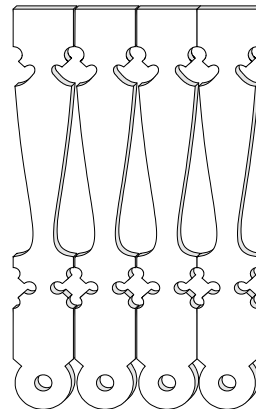

Drage

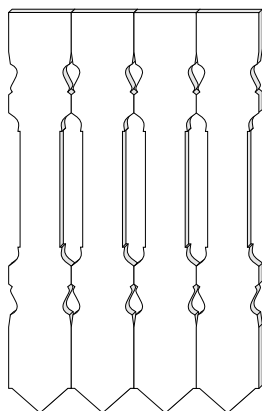

Stjerne

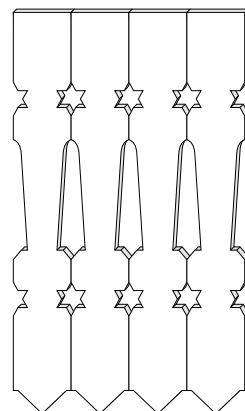

Sveitser 2

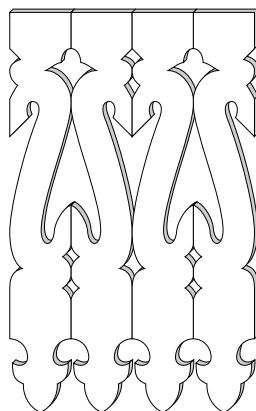

Megler

115x115x1035mm eller
115x115x1270mm

Profilerte bord med endeprofil, leveres i kvistfri furu 19x123x830mm

Montering med søyle-fotbeslag

EKS søyle-fotbeslag gir stor fleksibilitet, en sikker og profesjonell montering. Beslaget skrues først fast i søyle/ megler, deretter i gulvet. Avstand mellom meglere max 2000mm. Bruk rustfrie skruer og MS polymer 25 % elastisitet til monteringen.

